

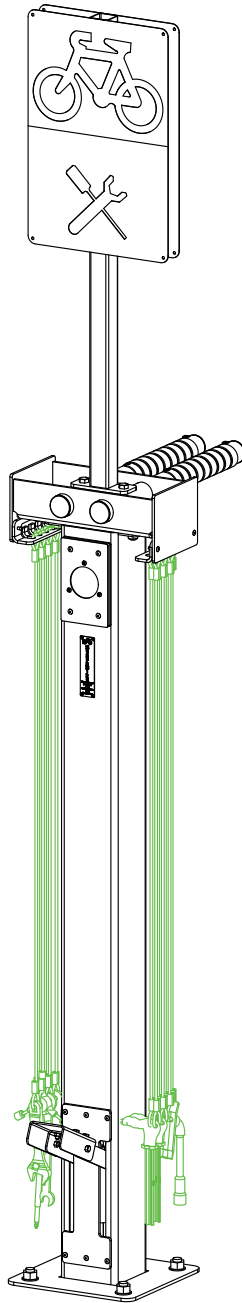

# BRST01 INSTALLATION MANUAL



ISSUED:10/10/2016  
REVISION:A



# Parts and Fittings



A



B



C

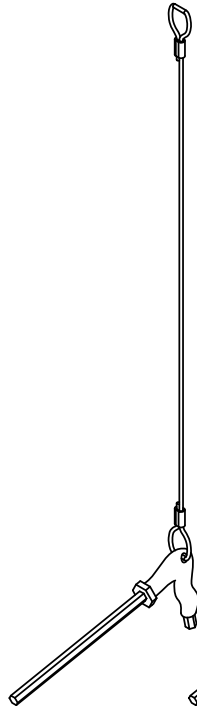

D

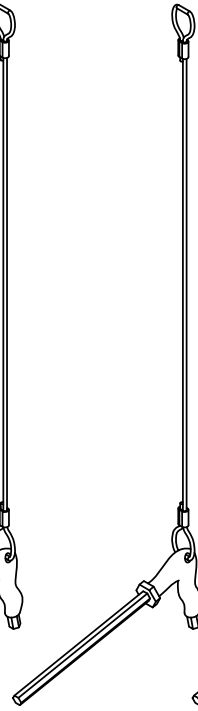

E

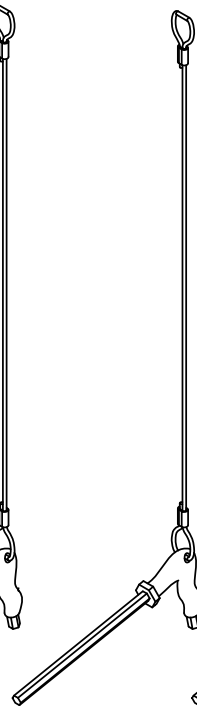

F

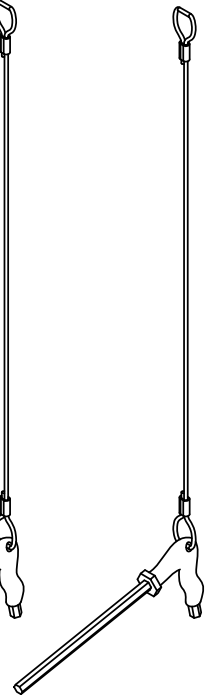

G

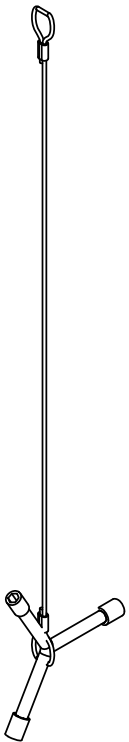

H

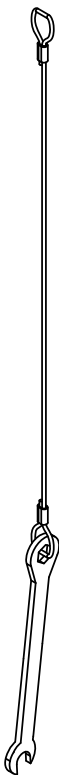

I



J



K



L

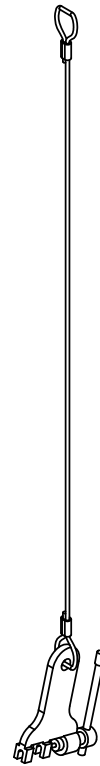

M



N

# Materials

<b>Number</b>	<b>Description</b>	<b>Quantity</b>
A	Socket Wrench 14mm	1
B	Screwdriver Flat Head 3mm	1
C	Screwdriver Phillips Head #2	1
D	Hex Wrench 4mm	1
E	Hex Wrench 5mm	1
F	Hex Wrench 6mm	1
G	Hex Wrench 8mm	1
H	3-Way Socket Wrench 8mm9mm10mm	1
I	Pedal Wrench 15mm	1
J	Tyre Levers Plastic	1
K	Tyre Levers Steel	1
L	Adjustable Wrench 150mm×6 inch	1
M	Chain Tool	1
N	4.8*10mm SS304 Rivet	4

# What you will need

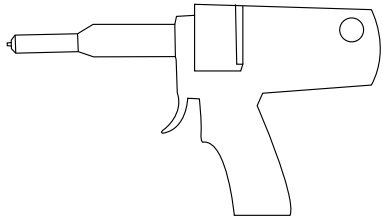

rivet gun × 1

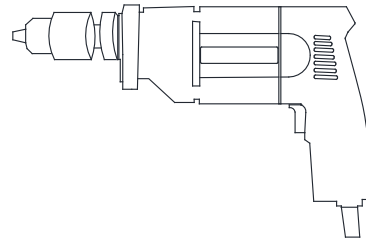

masonry drill × 1



5mm drill bit × 1

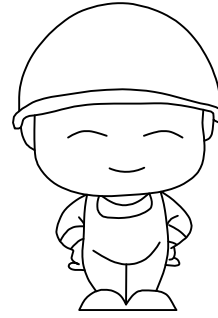

worker × 1

# Tips

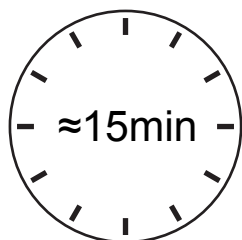
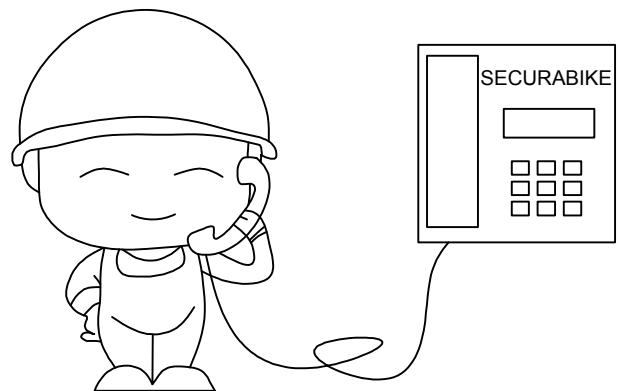
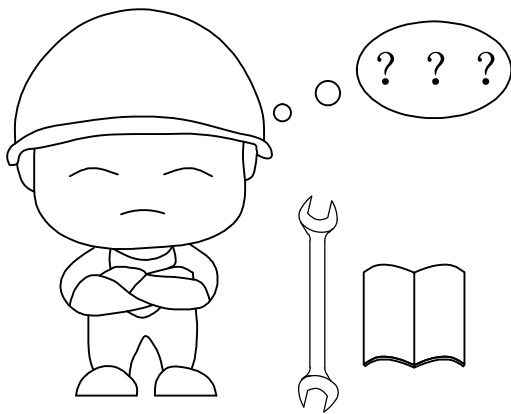

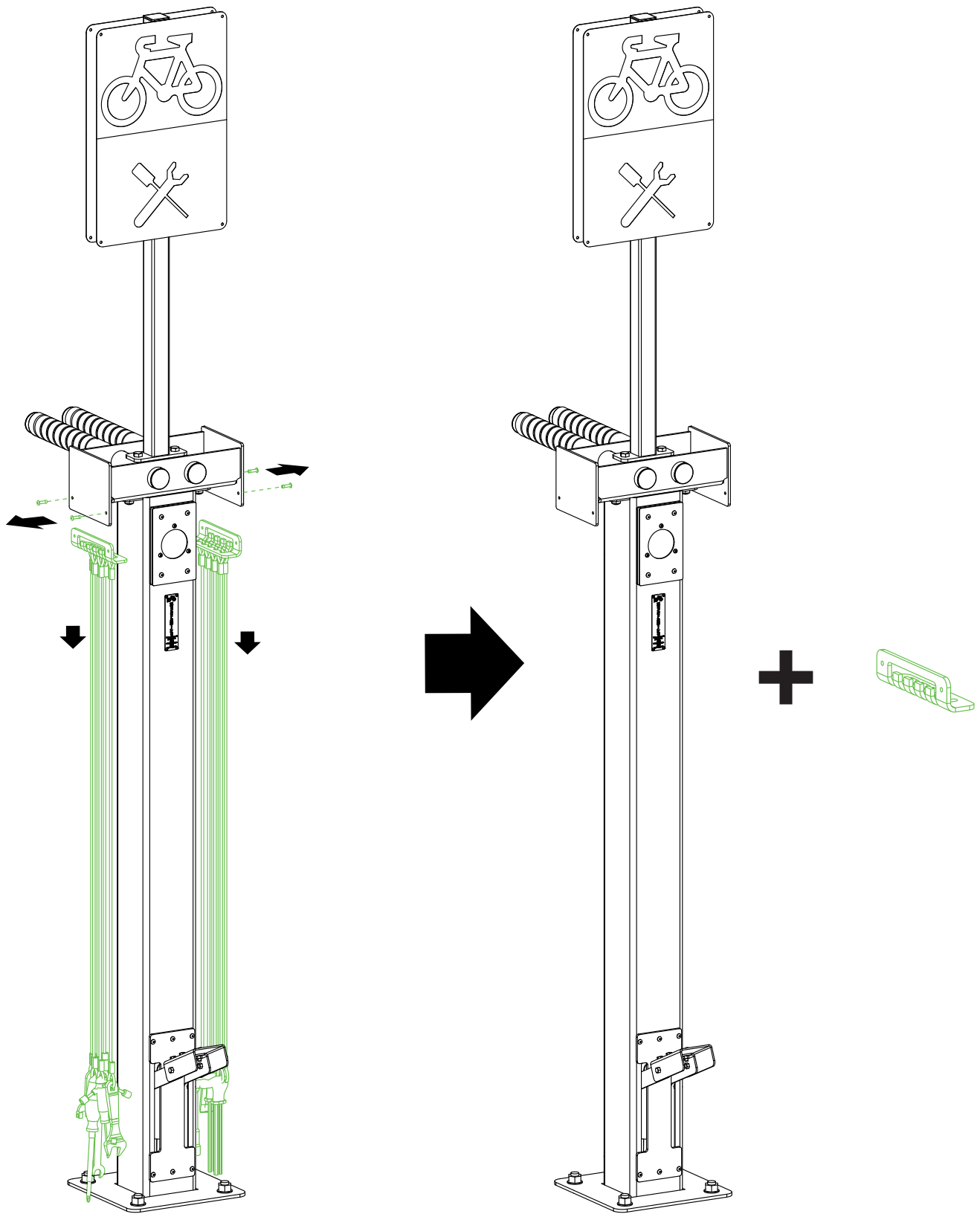

TO REPLACE EACH BRST01

# Step 1. Remove Old Tool Kits

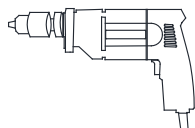

 ×1

 ×1

 ×1

# Step 2. Assemble New Tool Kits

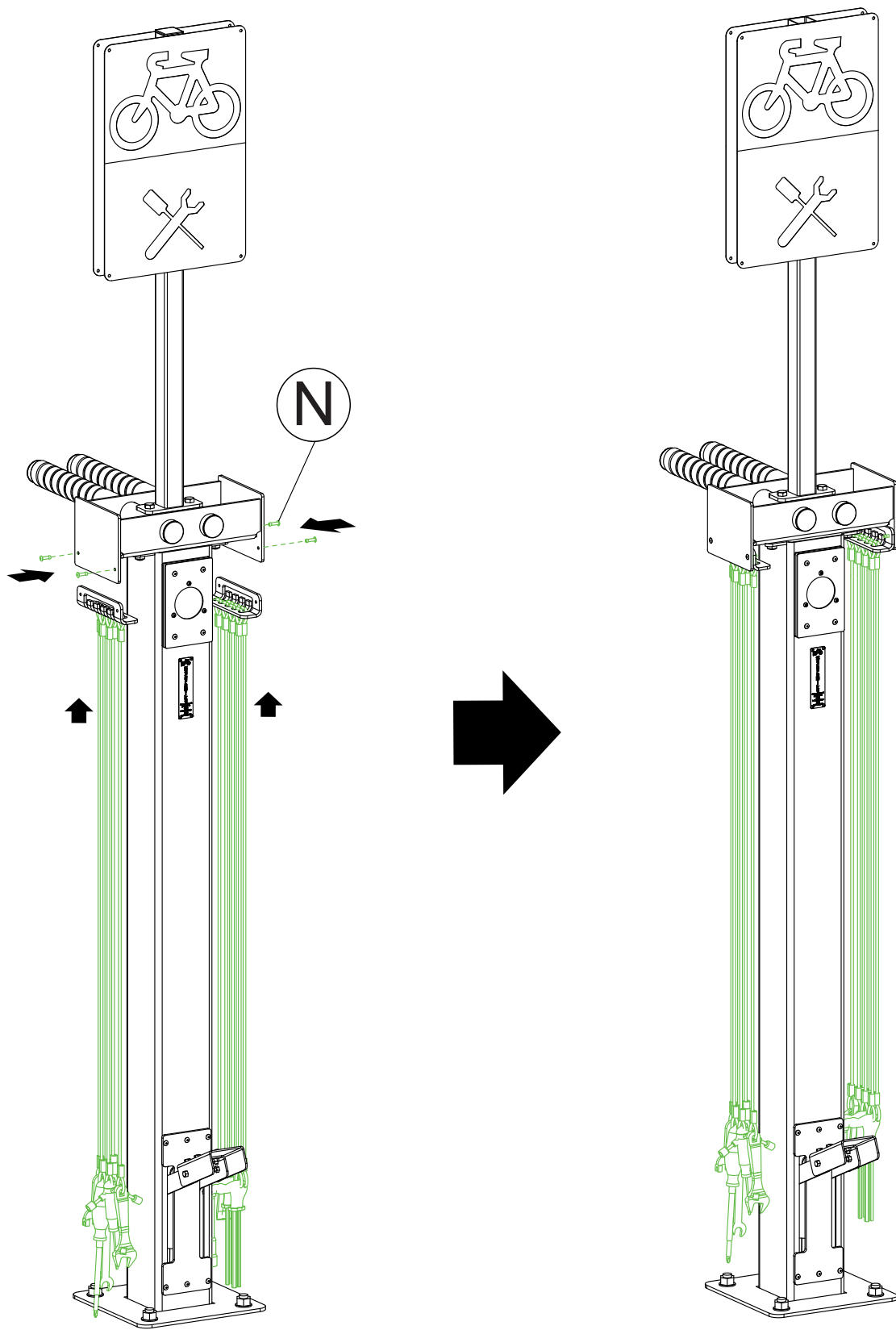

(A) - (M) x1

(N) x4

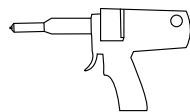
 x1

 x1